

Automation solutions for the automotive industry



A photograph of an automotive assembly line. In the foreground, a dark-colored car is suspended on a yellow overhead conveyor system. The car's engine and front components are visible. In the background, another car is further along the line. Two workers are visible on the floor; one is wearing a white shirt and a cap, and the other is in a dark shirt. The factory floor is cluttered with various tools, equipment, and structural beams. A large black fan is mounted on the ceiling. The overall scene is a busy industrial environment.

More than
30 years
experience
in the
automotive
industry.

As one of the leading automation specialists with extensive know-how in the automotive industry and a worldwide network of experts, we work closely with you to find the best solution for your needs. We love being able to set your ideas in motion, regardless of whether you want to upgrade an existing machine or develop a completely new one.

In accordance with your ideas and requirements, we provide all the support you need – from the planning of individual production plant sections or complete systems to commissioning and start-up of the installed equipment.

We develop innovations for the car production – as easily as that:

- Experienced experts understand your requirements and goals
- A comprehensive automation platform consisting of modular software and scalable hardware
- Reliable drive systems for typical manufacturing applications.
- Use of open standards
- Global production with uniform Lenze quality standards
- Worldwide logistics concept
- Global service network and range of training courses offered



A comprehensive Lenze automation platform: Scalable for your machine.

Comprehensive and open

Our automation platform offers you everything from the control level to electromechanics for the implementation of a wide range of tasks. Thanks to our energy-efficient mechatronic portfolio of reliable technologies, you benefit from long-lasting quality and easy handling of all our products.

Furthermore, our platform is also open for the efficient integration of components from various partners.

Compliance with market standards

We are able to network ourselves with control and drive systems at any time. This enables easy integration into higher-level line topologies. This openness makes mechanical engineers and users confident of being able to adapt to changes in the future. Keep your core expertise in-house and hold onto your competitive advantage.

IT and OT in a single device

comprehensive solution is also one that brings the two worlds of IT and OT increasingly closer – industrial PC and PLC combined in a single device. Whether it is about having tools available at the machine at all times or aggregating data directly on site – this is a further step towards more flexibility and the response to the increased requirements machines have to fulfil.



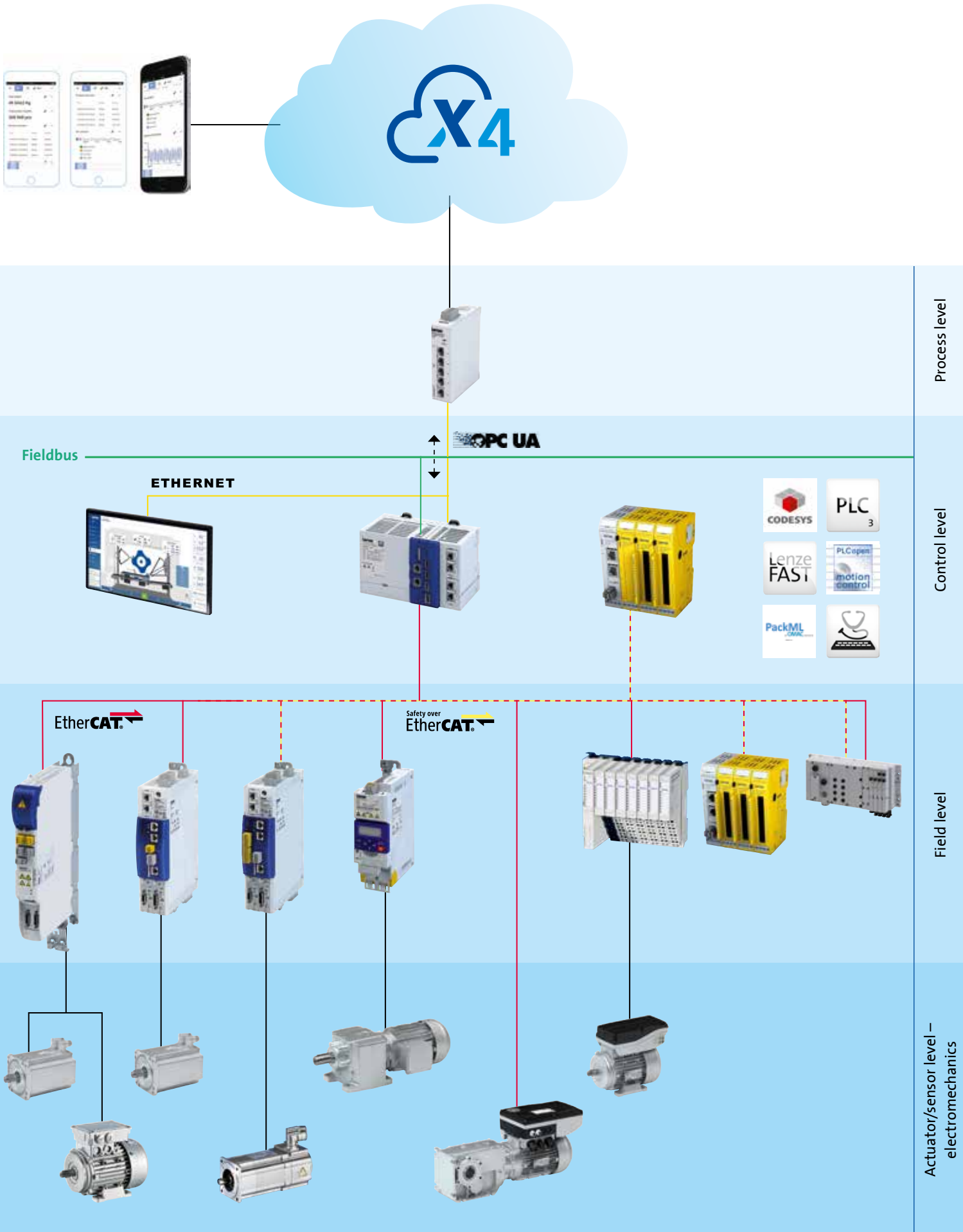

Extremely demanding production requirements: networking, high throughput rate and safe and reliable processes.

Production in the automotive industry is influenced by two crucial factors: just-in-time and just-in-sequence. Both of these have to be guaranteed at all times as, whenever a part of the factory is shut down, enormous costs are incurred as a result. Our Intelligent automation concepts combined with flexible and efficient drive solutions enable compliance with these essential two requirements.

Irrespective of the process within the production plant, whether it be the press shop, body shop, paint shop or assembly section, our experts know your processes and can help you to work faster and more reliably, whilst ensuring efficiency and reducing energy consumption.

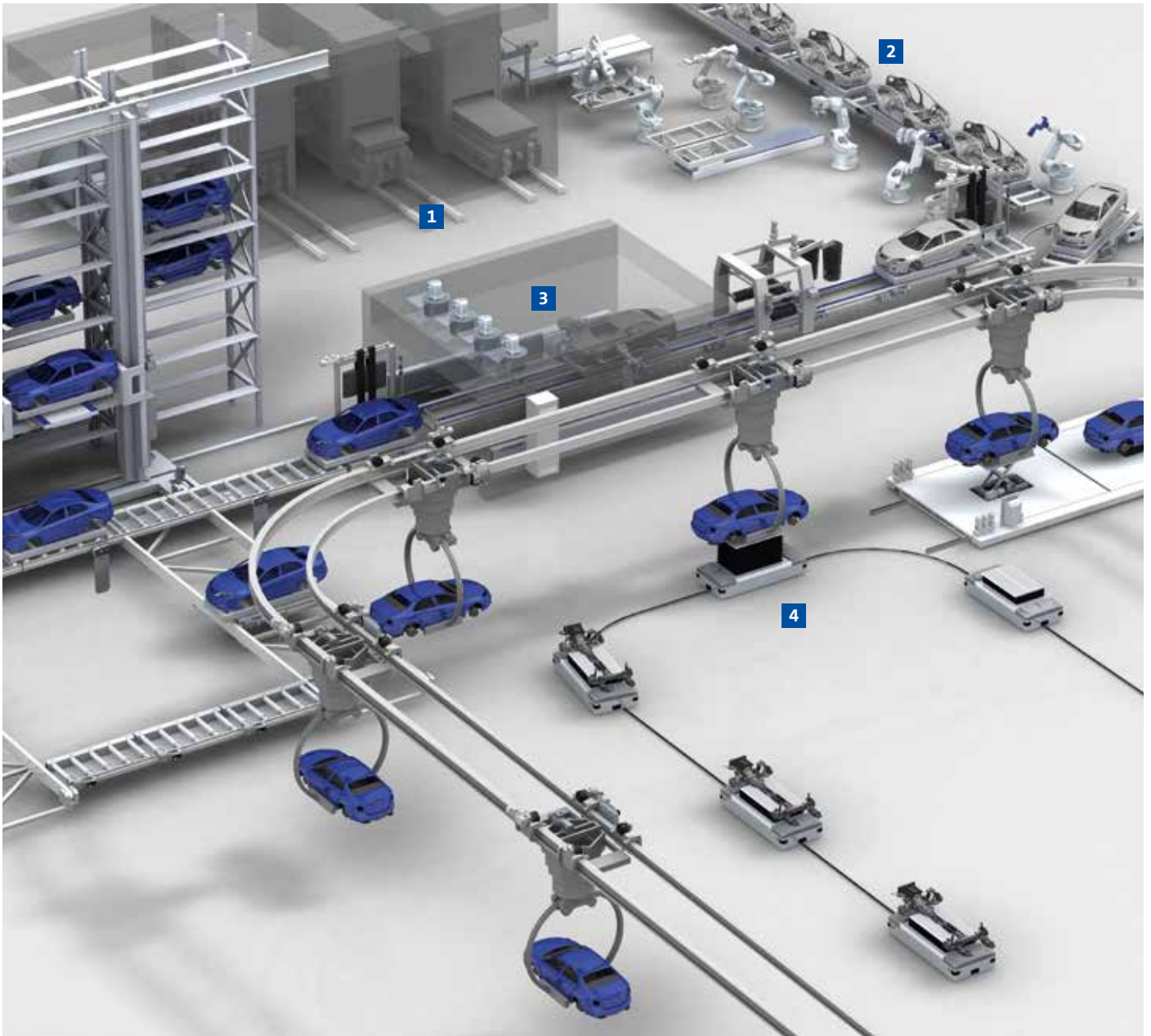

1 Press shop

2 Body shop

3 Paint Shop

4 Assembly

Conveyors and turntables: efficiency in motion.

- Simple and efficient decentralised drive solution for variable and fast conveying speeds of horizontal material handling systems
- High degree of reliability due to more than 30 years experience in the area of material handling technology
- Reduced energy consumption during idling and partial-load operation utilising the „VFC eco“ energy saving function
- Soft starting and braking with adjustable ramps mean less strain and stress on material and goods being transported, while simultaneously reducing the amount and cost of maintenance work needed
- Minimal installation and wiring complexity due to decentralised drive concept
- Compact drive solution for constant speeds, even in heavy load conditions



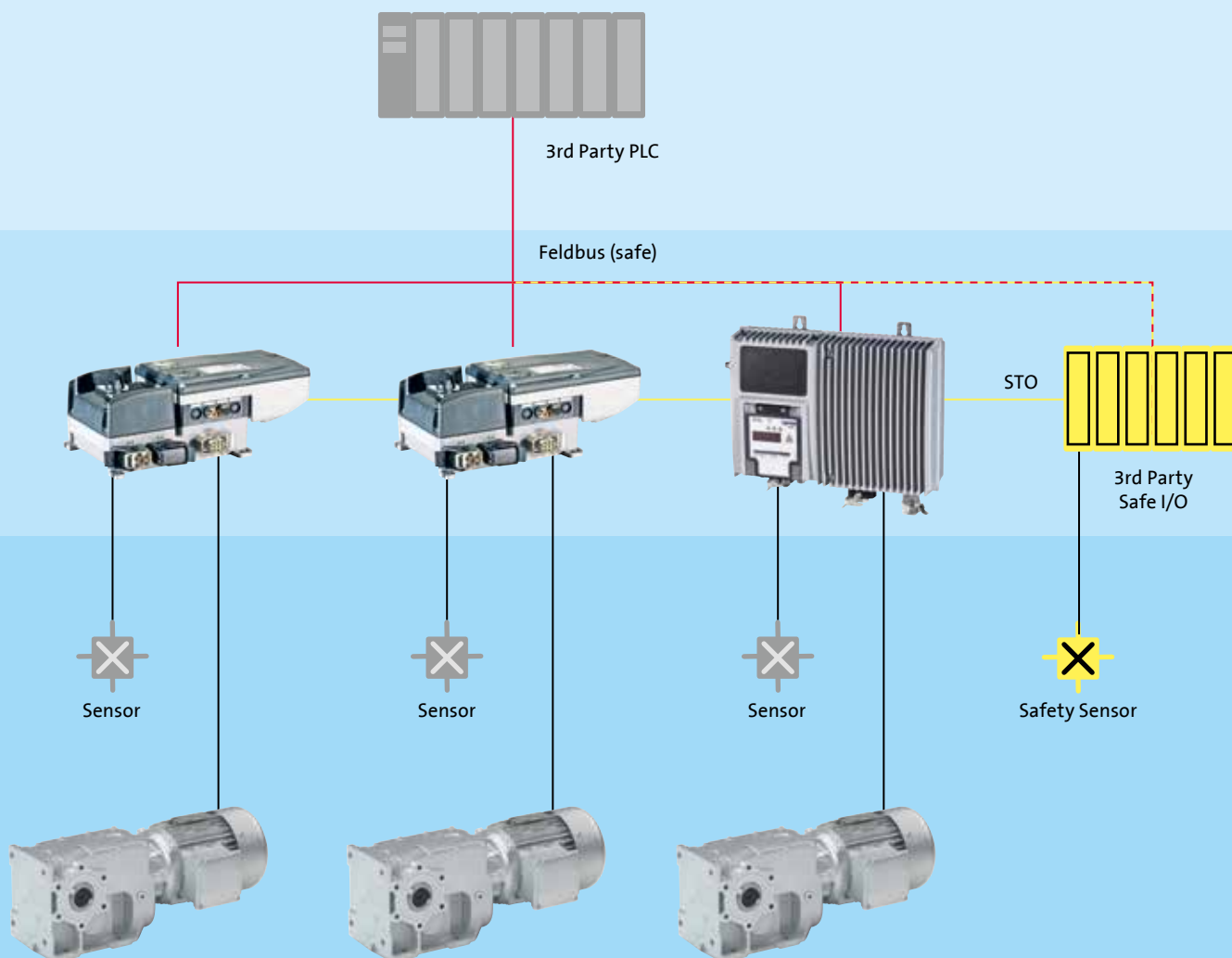
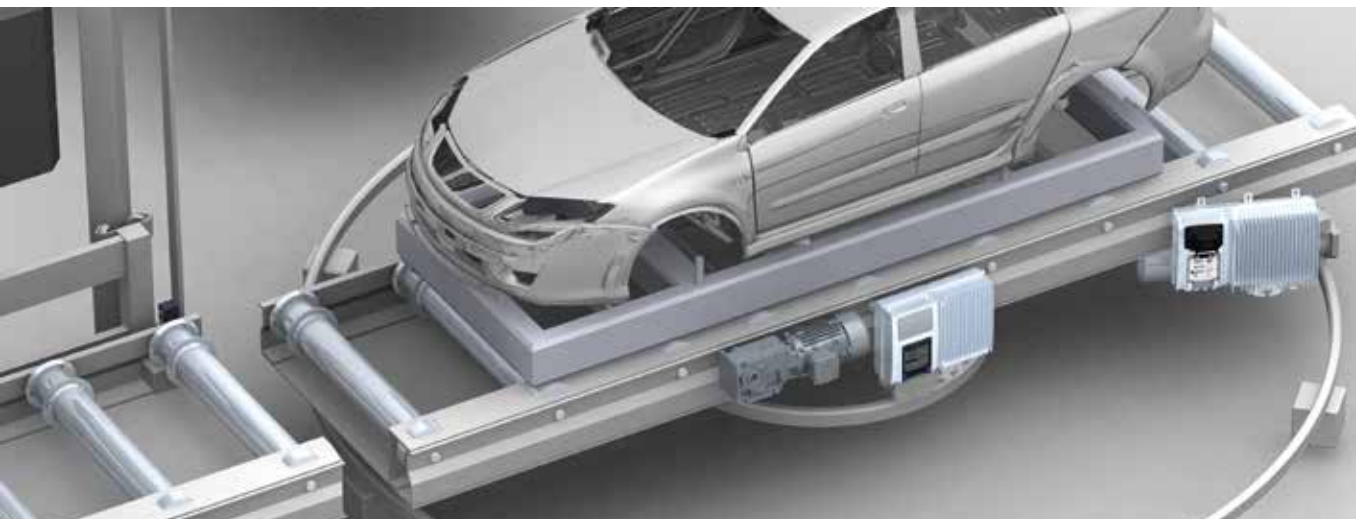

Lifter and assembly facilities: for the strictest requirements.

- High degree of reliability where great heights have to be overcome thanks to low-wear brake management
- As the load is held in position at standstill, the brake is not applied therefore less stress is applied to the system
- Fast and easy replacement during maintenance thanks to pluggable technology
- Reduced energy consumption due to power recovery in the case of very large heights



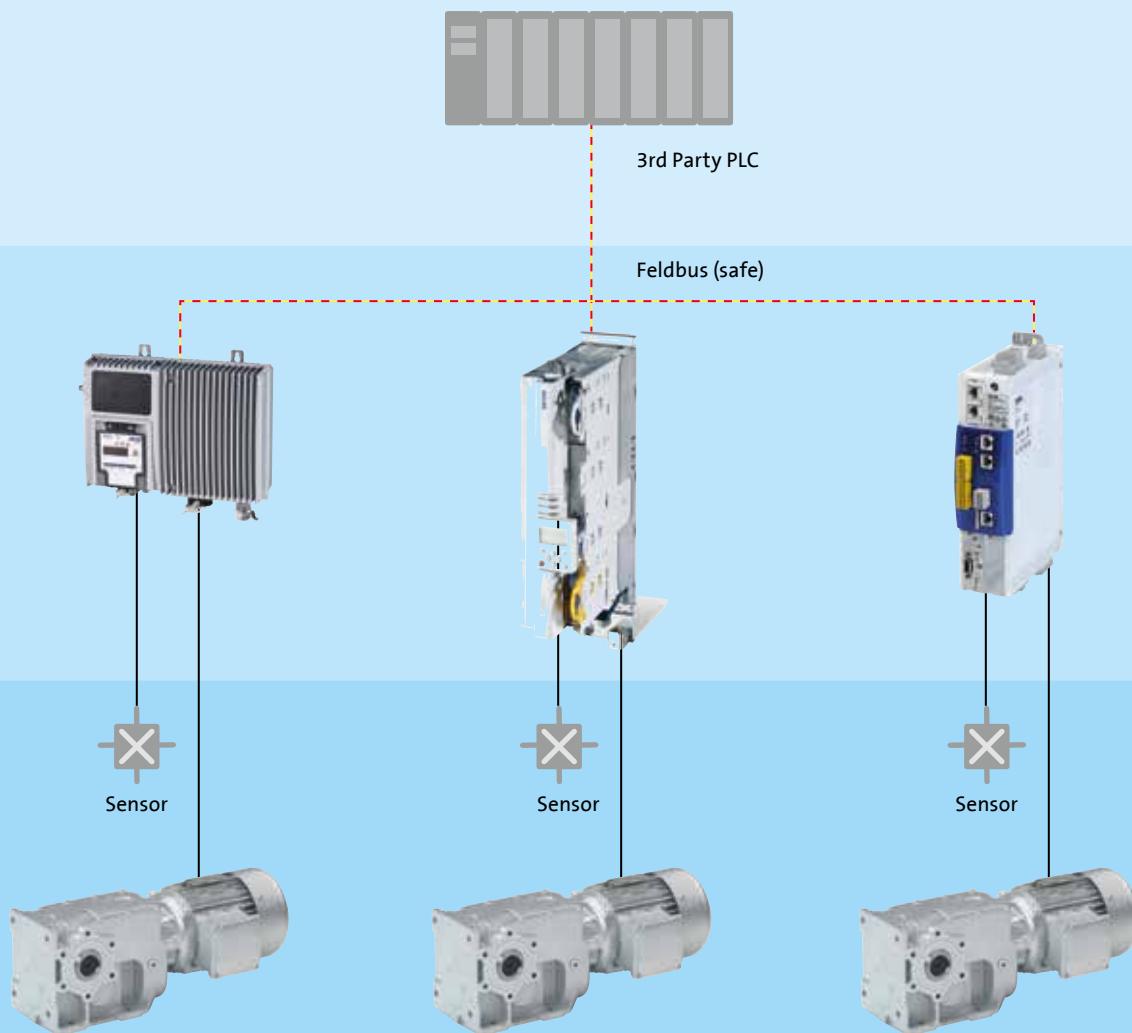

Control level

Field level

Actuator/sensor level - electromechanics

Storage and retrieval unit: highly automated warehouse worker.

- Complete solution package for advanced storage and retrieval units of the next generation
- Easy commissioning due to ready-made technology functions
- More available storage capacity due to reduction of buffer zones
- High degree of availability due to decades-long experience with storage and retrieval units
- Reduced energy consumption due to DC bus connection of travelling drive and lifting drive
- Regenerative modules for optimum energy balances

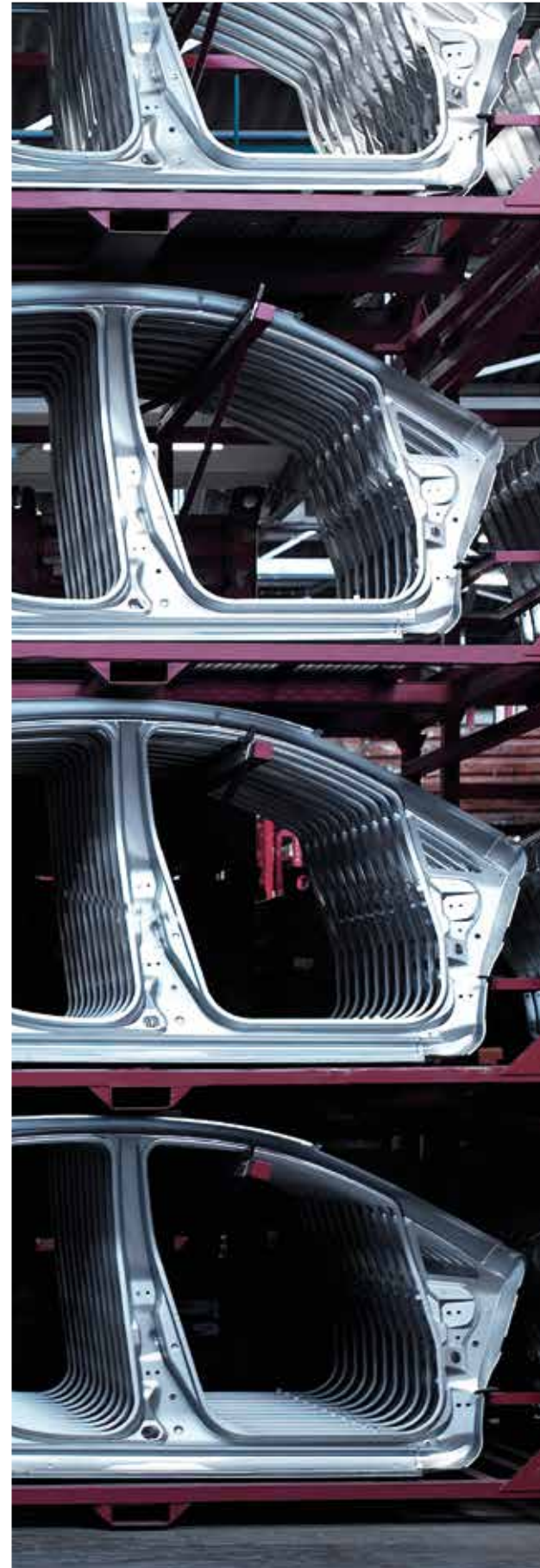

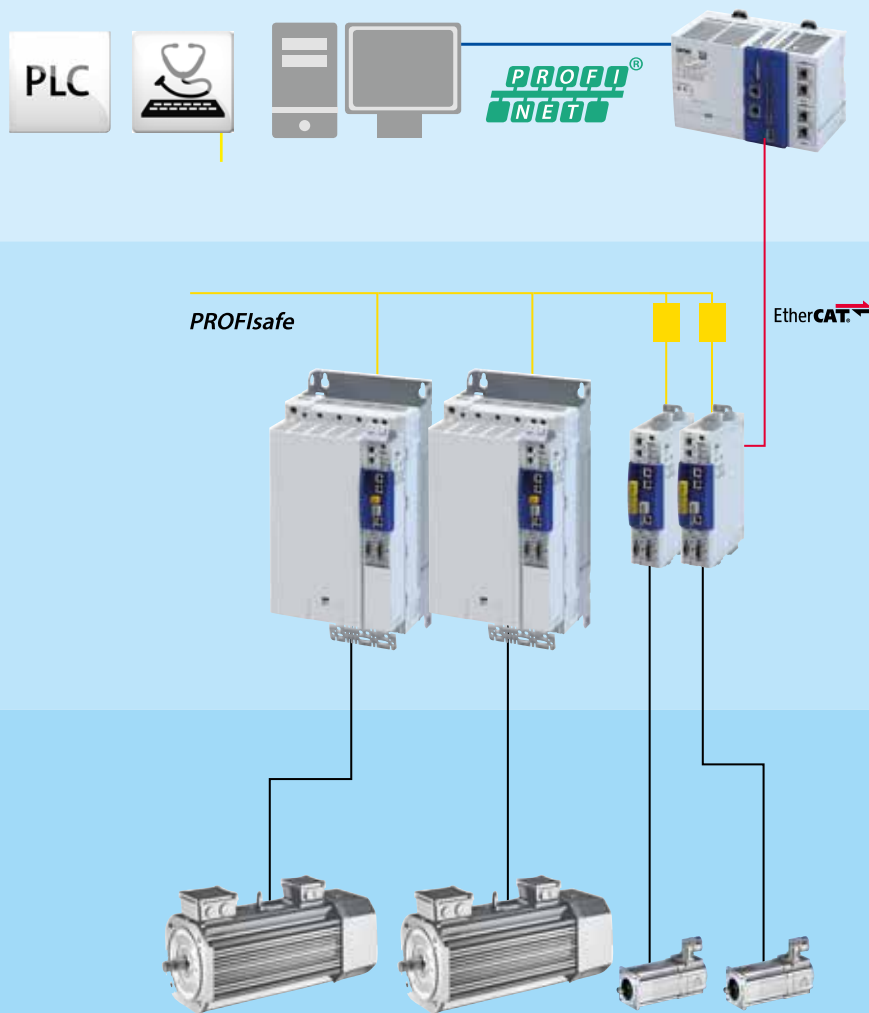

Control level

Field level

Actuator/sensor level – electromechanics

Clinching & riveting: Always the best connection.

- The high precision of the servo axes enables the innovative and proven clinching method
- The exact torque of our motor ensures that permanent connections can be made solely on the basis of local cold forming without the need for supplementary or auxiliary joining components
- The integration of external sensors into our automation system enables the autonomous performance of joining tasks in the pre-series and small-series area
- The intelligence in our inverters makes it possible for process measurements that have to be documented to be organised in the inverter and made available as a data file



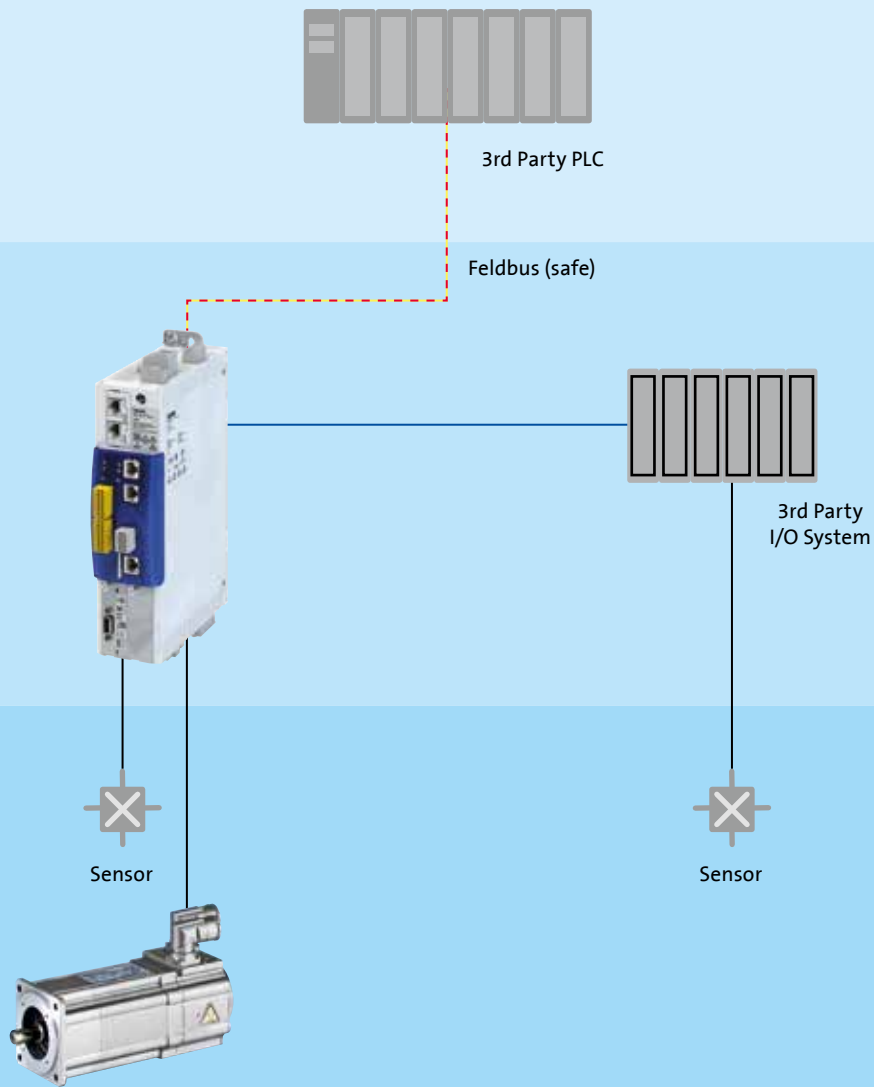
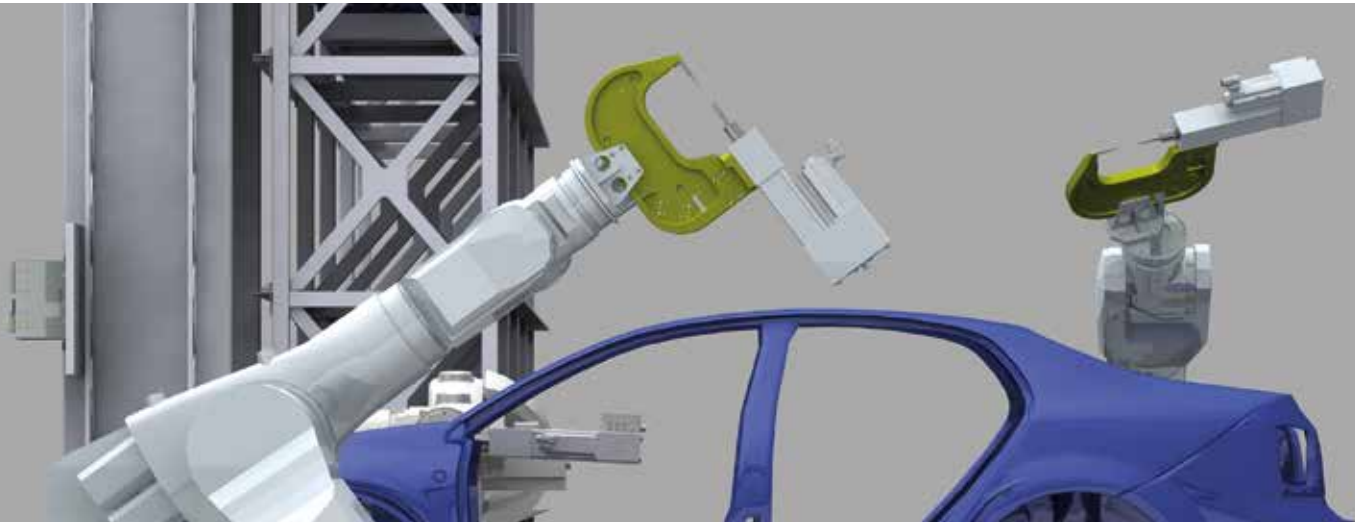

Control level

Field level

Actuator/sensor level – electromechanics

Lenze Digital Services: Added value with perspective for OEMs and end users.

For end customers, the supervision of the operating phase of a machine by the OEM is added value which is becoming increasingly important. In this context, digital services offer the possibility of tapping into new turnover potential and strengthening profitability in core service activities.

Together with us, you will develop your tailored digital journey and define steps for your digital offerings which are feasible and realistic for you – today, tomorrow, and in the days that follow. With our digital product and solution portfolio, we support you in every phase of this endeavour.

TODAY

Obtain transparency regarding the installed base and reduce expenditure for service activities. With X4 Remote, we support you with a turnkey cloud solution in the areas of remote maintenance, data storage and data visualization, as well as condition monitoring.

TOMORROW

Assist end customers with digital services related to your machine when optimizing availability, throughput, and production yield.

IN THE FUTURE

Based on the data recorded over a longer period of time, you can derive predictive data models and obtain insight into what will happen.



TODAY

What is happening?

- Connection of all machines to a central cloud infrastructure without special IoT know-how
- Remote maintenance and condition monitoring from any mobile device with a web browser
- Autonomous creation of dashboards with the aid of widgets at the click of a mouse

Benefits for OEMs

- Secure and transparent access to remote maintenance
- Reduction in commissioning costs
- Reduction in support costs through efficient remote maintenance
- Retrospective fault analysis

Benefits for end users

- Secure and transparent access to remote maintenance
- Higher machine availability through faster fault elimination by the OEM

TOMORROW

What will happen?

Optimization of availability, throughput, and production yield with the aid of KPIs (OEE, MTBF) in real time.

Benefits for OEMs

- New turnover potential via digital added value services related to one's own machines
- Record of the contractually assured machine availability
- Optimization of machines based on recorded data

Benefits for end users

- Reduction in unplanned downtimes because the reasons for the downtime are known
- Realtime and historical OEE data are displayed
- More efficient utilization of the entire machine outfit
- Performance analysis within a multipoint line configuration

IN THE FUTURE

What comes next?

Increased availability and process quality via predictive analytics.

Benefits for OEMs/end users

- Higher OEE (Overall Equipment Effectiveness)
- Better product and process quality
- Plannable maintenance periods
- Longer maintenance intervals and lower maintenance costs
- Foray into new business models
 - Pay per use
 - Performance-based
 - Contracting
 - ...

Lenze FAST: Efficient software engineering.

The engineering process is becoming increasingly digital. Whether it is higher machine flexibility which allows for batch sizes of 1 or improved productivity: Machine software is increasingly becoming the focus. Our modular software system, the Lenze FAST Application Software Toolbox,

incorporates the experience from several thousand realised applications. Ready-made and tested technology modules reduce development time for technology-specific basic functions, thereby simplifying the implementation of machine functions.

FAST Application Template

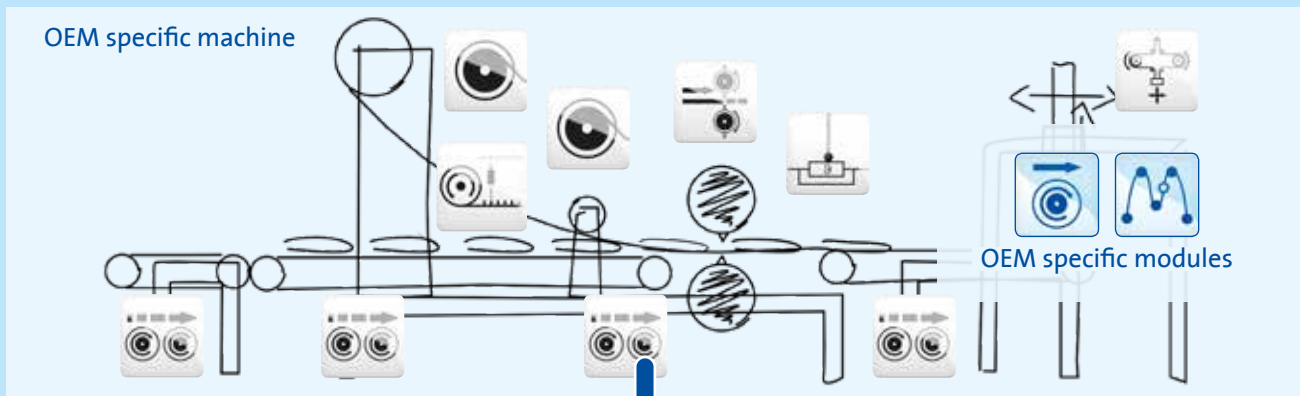

FAST Technology Modules



For better software quality, the technology modules can easily be reused. They can be used directly by the OEM or form the basis for the development of custom modules,

thus allowing a machine to be programmed efficiently. A structured programming layout takes place via the Application Template.

EASY Engineering Tools: The right software tool for every task.

Do you want to plan, build or commission machines? Adjust existing machines or run diagnostics? Regardless of whether you require simple applications or maximum precision and dynamics:

You can choose the right tools for you and perform your engineering more rapidly and easily.

Planning

- Conception
- Product selection
- Dimensioning
- Quotation requests
- Ordering

Implementation

- Parameterization
- Configuration
- Programming
- Debugging
- Setup
- Interface design

Operation

- Commissioning
- Diagnostics
- Troubleshooting

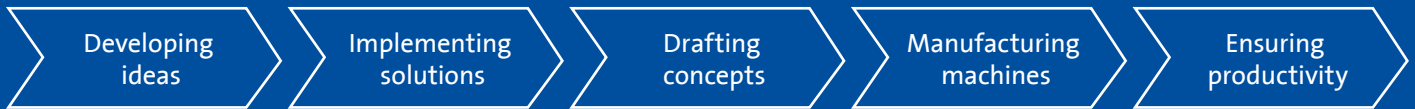

EASY System Designer
Plan automation solutions



Drive Solution Designer
Design drive solutions



PLC Designer
Program the controller



EASY UI Designer
Machine visualization



EASY Starter
Parameterization and operation

Engineering services: Together we develop solutions.

We see ourselves as your one-stop solution partner and apply all our know-how to develop the best possible package in partnership with you. Because you are the expert when it comes to your machines and the corresponding requirements. We are the experts for machine automation and our entire automation platform. With our engineering services, we

accompany and support you throughout all phases of the engineering process on the path to the perfect solution for your machine tasks.

You benefit from:

- Scalable hardware
- Modular software
- Brainware

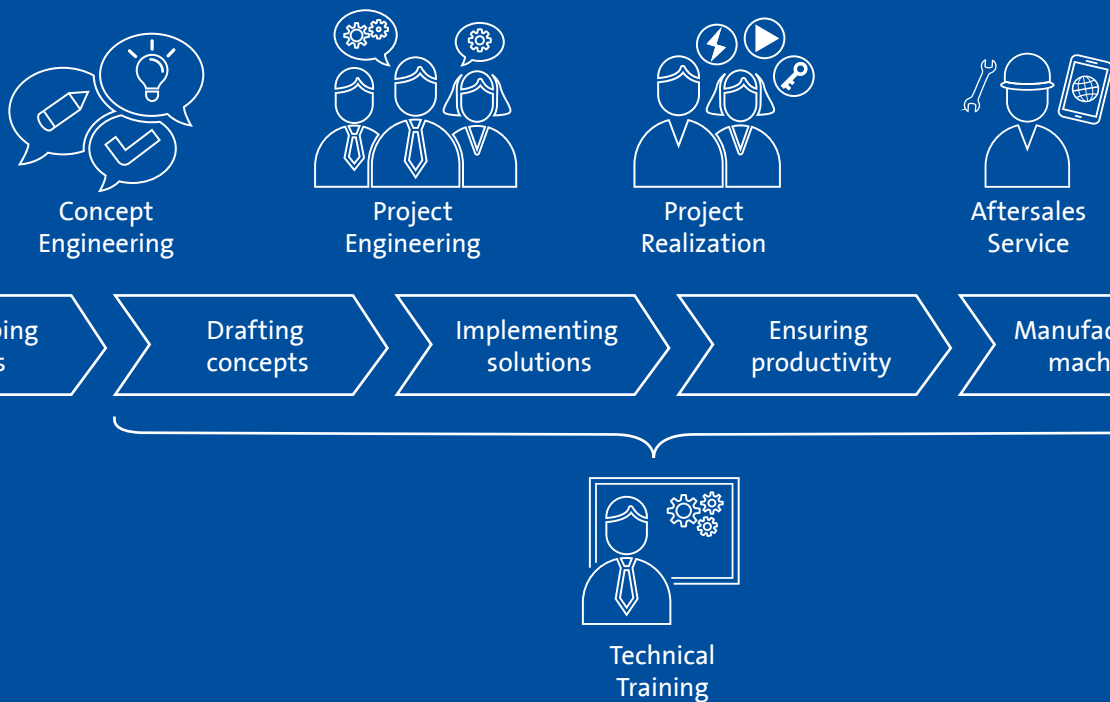

Concept Engineering

- The basis for the best solution for your machine task is that we first learn to understand your processes and your organization
- Building on this, we show your engineers how your machines can be developed efficiently and fully utilizing all possibilities with our automation solutions.



Project Engineering

- The use of a Lenze automation system provides you with long-term advantages, but also short-term challenges
- Integrated project management supports smooth workflows when creating your
 - Functional concepts
 - Hardware concepts
 - Engineering concepts



Project Realization

We offer you a complete solution by also assuming responsibility for the electrical design and the commissioning of the system

Technical Training

- With an individualised training concept, we prepare you for the planning, implementation, and operation of your machine
- Our training courses are application- and practice-oriented and enable you to immediately integrate what you have learned into your day-to-day work
- To offer you flexibility and time savings, our offerings include:
 - On-site training programmes
 - Online training
 - Video tutorials



Aftersales: Worldwide service for the requirements of your industry.

You can rely on every aspect of our high quality standards. From our extensive range of services to our consistent product portfolio, you also stand to gain from short delivery times, outstanding product quality and a local partner service, focussed fully on your needs. This is all made possible by our 60 sales and service locations throughout the world.

Our service modules have been specifically set up to guarantee the reliability of your machine and increase its performance. And should anything unforeseen ever occur, we will make sure your machine is back up and running again quickly. From inspections and preventive maintenance, through optimization, all the way up to our emergency service – you are free to use any of our services individually or as a tailored process chain..



Lenze inspection

What is the current status?

You know your machine extremely well. We work together with you to create a basis for taking the appropriate measures. For example, we identify weak points or risks and tap valuable performance reserves. One thing is certain: with us, your machine is in the best hands.



Lenze prevention

Prepared for the unexpected.

Our comprehensive preventive service is the ideal way to minimise potential risks to your machine. We support you in increasing machine availability and minimizing reaction times and downtimes in the event of faults. This saves you time and money – and soothes your nerves.



Lenze optimization

Making the good better.

We ensure that your systems work perfectly and show you intelligent optimization possibilities: this includes reducing your energy costs, shortening your set-up times for production changeovers, or improving efficiency. We take care of it.

Lenze emergency service

Ready for any situation.

You can also rely on us in the event of an emergency. We make extensive preparations for potential problems. Should something unforeseen ever occur, we will make sure that your systems are back up and running quickly and also perform an in-depth error analysis. With us, your projects are in safe hands.

Efficient in all respects.

Energy-efficient with Lenze BlueGreen Solutions

On the basis of a holistic consideration of the tasks involved, we show you how the energy efficiency of your drive applications can be increased with intelligent drive and automation technology. We also assist you regarding adherence to important standards and laws. Three approaches are pursued in order to increase the energy efficiency of drives:

1. Using electrical energy intelligently: as little as possible

- Needs-based dimensioning
Controlled operation (frequency inverter)
- Energy-efficient motion control

2. Converting energy with a high degree of efficiency

- Components with a high degree of efficiency (motors, gearboxes)

3. Using regenerative braking energy

- Energy exchange between several drives
- Temporary storage of braking energy
- Regeneration of braking energy and potential energy

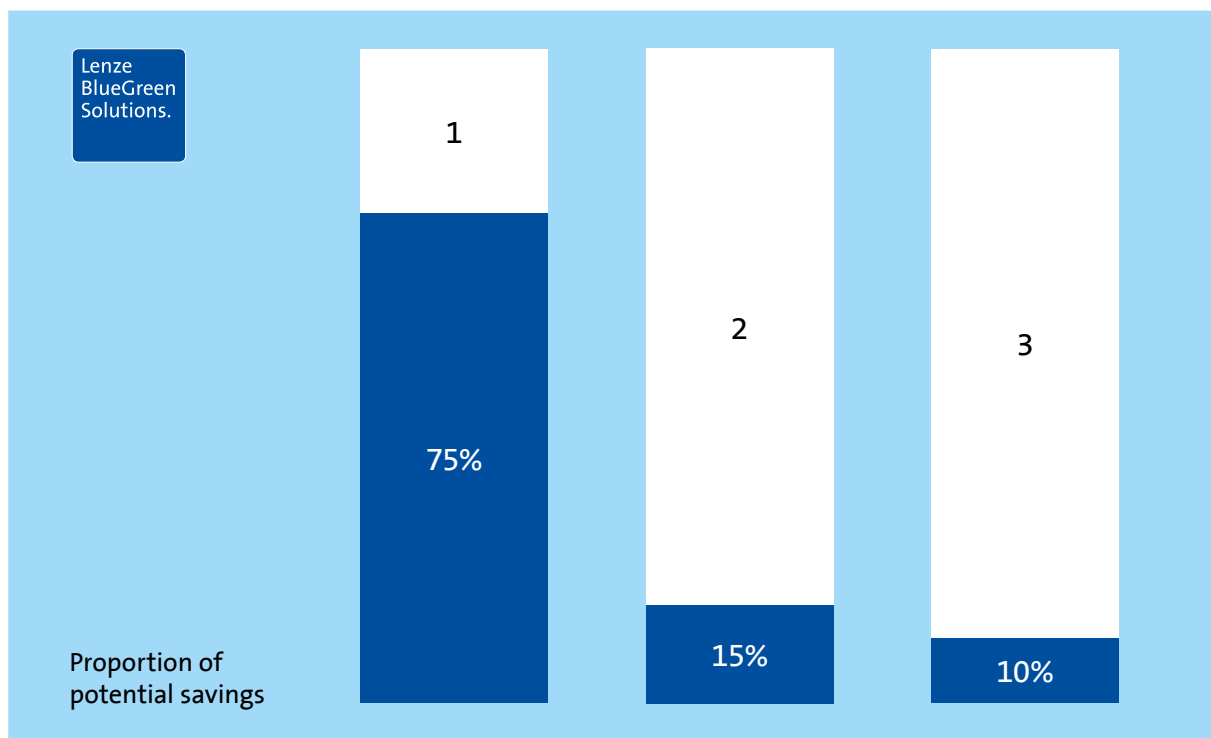

Efficient drive sizing with Drive Solution Designer (DSD)

Intelligent drive design is the basis for a drive system that has the right components, is exactly dimensioned and is therefore as small as possible. Thanks to DSD, the energy saving potential is apparent at a glance and is documented in the Energy Performance Certificate. It is also easy to comprehensibly compare different solutions.

The reason is that DSD incorporates a great deal of useful systems-design knowledge – with solidly based drive-applications know-how in areas such as drive physics, variants and energy efficiency. Drive design is based on calculations with individual process data and on speed profiles, and takes into account the complete drive structure for the requirements of the machine in question.

In our DSD training course, we will be happy to tell you more about how easy it is to use this engineering tool.

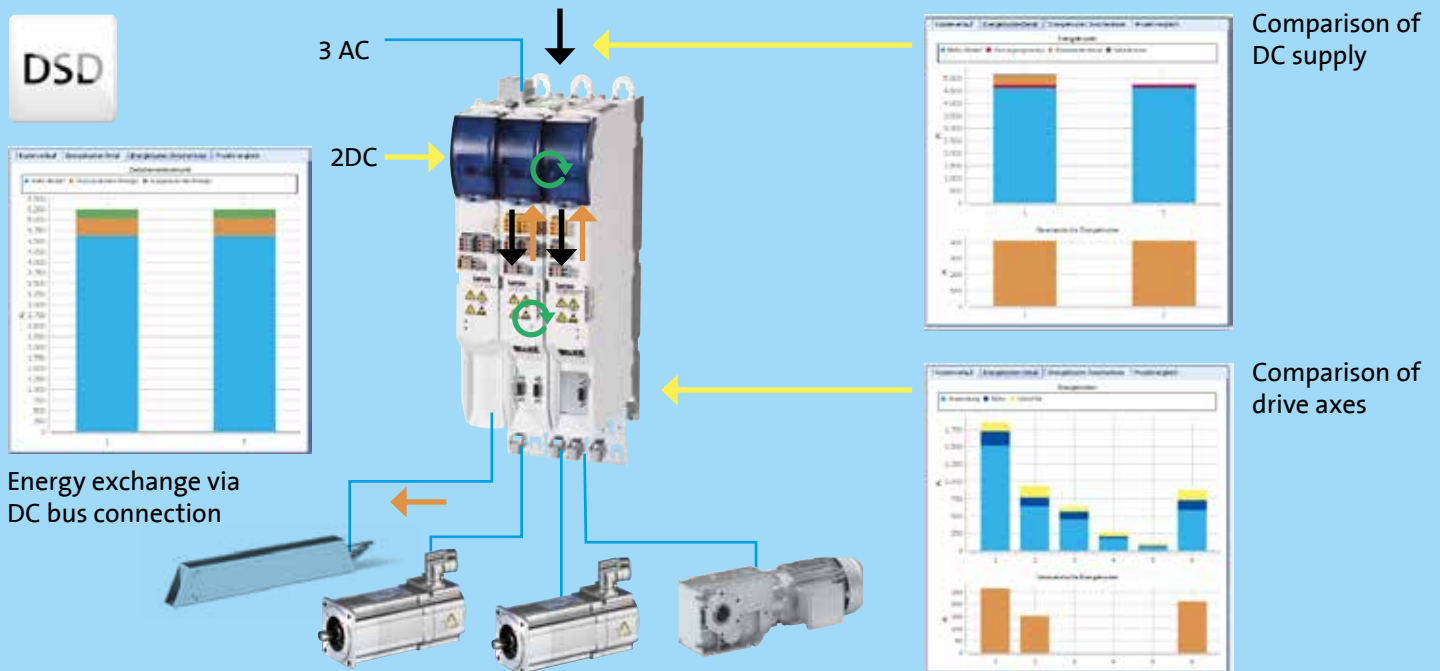

A powerful performance in any situation.

If you can react individually and quickly to continually shortened delivery times, burgeoning costs and increased capacity requirements, you have a considerable advantage. We, as a company, have adjusted to these challenges and, with our many years of know-how in drive design and our adapted product portfolio, we can support you in this regard in accordance with your specific needs!

Ready for anything:

Well thought-out systems enable device replacement during ongoing operation

- The scalability of the products considerably reduces the variety of devices needed
- Need-based drive sizing with optimised energy balance
- Functional safety technology
- Intelligent systems for bridging short power-supply interruptions as well as for generator-controlled shutdown of the line in the event of a power failure





Central/distributed drive technology

- Distributed drive solution
- Integrated safety technology
- Flexible interfaces for fieldbus connection



Fast and easy replacement during maintenance

- Aluminium gearbox instead of heavy grey cast iron gearbox
- Pluggable connection system
- Parameterization by means of NFC
- Connection dimensions usual in industry



Safety technology

- Simplification of the structure of the system
- Less wiring/cabling
- Greater clarity
- Avoidance of the need for external safety components
- Increase in system performance
- Shorter switch-off and switch-on times



Needs-based drive design with Drive Solution Designer (DSD)

- In-depth knowledge about drive applications such as drive physics, variants and energy efficiency
- Calculations with individually applicable process data and speed profiles
- Complete drive structure for all of the machine's requirements
- Energy Performance Certificate makes savings potential visible at a glance



Easy engineering tools

- Software solutions for easy engineering
- Support for service technicians during commissioning and maintenance
- Graphic user interface with only a few buttons
- Easy online diagnosis, parameterization and commissioning
- No danger of accidental changes in the application
- Ready-to-use applications can be loaded into the device

www.Lenze.com

This document is the intellectual property of Lenze SE, Hamelin (Germany). All details and information included in this brochure are correct based on the information available at the time of publishing and serve only to provide preliminary information. Potential colour deviations from the original product are due to the printing process. Lenze is the sole and exclusive owner of the copyright and the intellectual property rights. Any use of this document, in particular dissemination, reprinting or adapting, it is only permitted following express written approval by Lenze.

13587980 · en · 11.2019

Lenze